

CAD FILE:

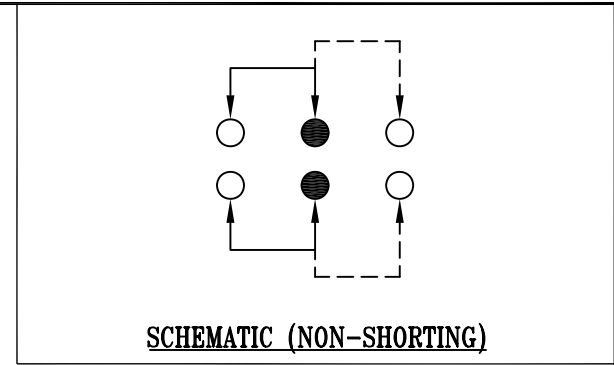

SCHEMATIC (NON-SHORTING)

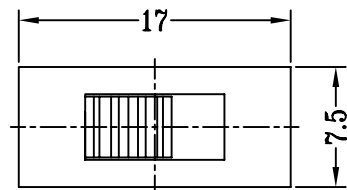
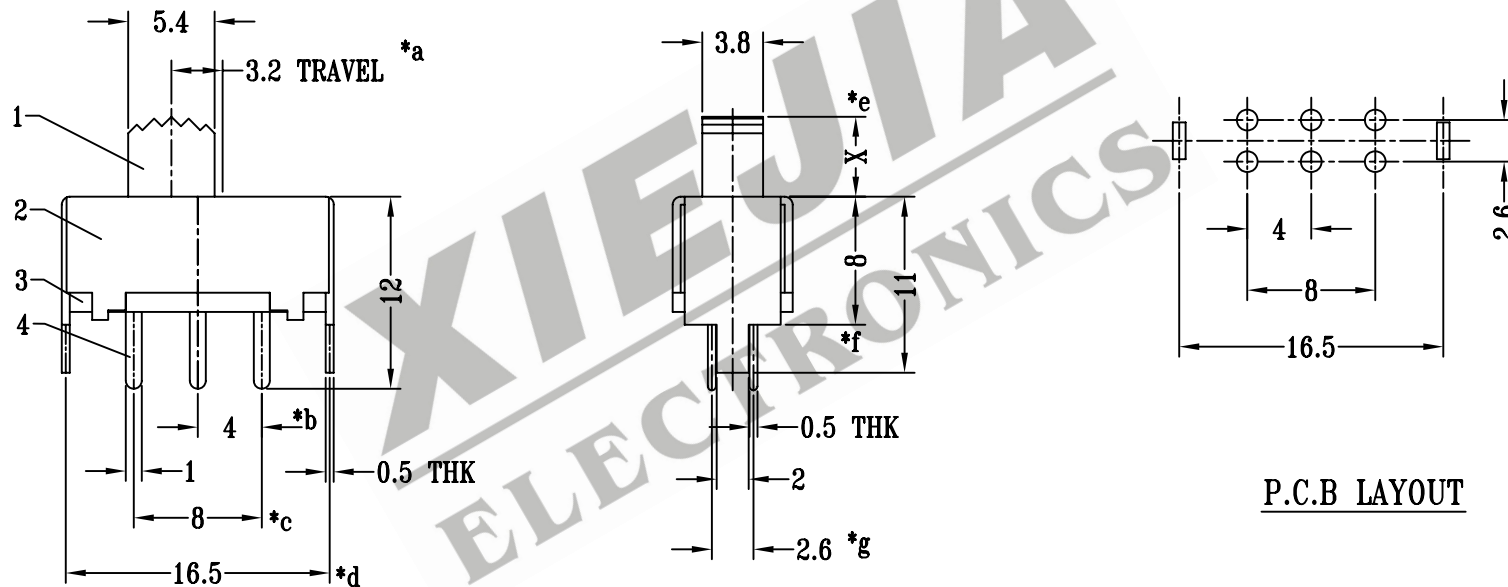

P.C.B LAYOUT

注:带"*"表示关键尺寸(7个)

8					TOLERANCE UNLESS SPECIFIED	SHENZHEN XIEJIA ELECTRONICS CO.,LTD.			
7									
6	SPRING	STEEL WIRE	2	TEMPER	WITHIN: 1.5±0.1mm	ISSUE	DATE	DESCRIPTIONS	APPD.
5	CONTACT CLIP	BRASS STRIP	2	Ag PLATED	OVER : 1.5±0.2mm				
4	TERMINAL	BRASS STRIP	6	Ag PLATED OVER Ni PLATED	TITLE : VERTICAL SLIDE SWITCH	UNIT : MM	DRWG NO.: XJ-DR-SS22F06-00		
3	BASE	PHENOLIC RESIN	1	BLACK	MODEL: SS-22F06	SCALE: 2 : 1	DWN.	ZHOUYU	2003-3-22
2	FRAME	STEEL STRIP	1	Ni PLATED			CHK'D	FANGYING	2003-3-22
1	KNOB	POM	1	BLACK	ALL MATERIALS MUST BE COMPLIANT TO ROHS	APPD.	KANGXINAN	2003-3-22	
NO.	PART NAME	MATERIAL	Q'TY	FINISHING					